

Gefen TOOLBOX

Extender for HDMI 3DTV

GTB-HDMI-3DTV User Manual



www.gefentoolbox.com

ASKING FOR ASSISTANCE

Technical Support:

Telephone (818) 772-9100
(800) 545-6900

Fax (818) 772-9120

Technical Support Hours:

8:00 AM to 5:00 PM Monday through Friday, Pacific Time

Write To:

Gefen, LLC.
c/o Customer Service
20600 Nordhoff St
Chatsworth, CA 91311

www.gefentoolbox.com
support@gefentoolbox.com

Notice

Gefen, LLC reserves the right to make changes in the hardware, packaging and any accompanying documentation without prior written notice.

GefenToolBox Extender for HDMI 3DTV is a trademark of Gefen, LLC

HDMI, the **HDMI** logo, and **High-Definition Multimedia Interface** are trademarks or registered trademarks of HDMI Licensing in the United States and other countries.

© 2011 Gefen, LLC. All rights reserved.
All trademarks are the property of their respective owners.

Rev A8

CONTENTS

- 1 Introduction
- 2 Operation Notes
- 3 Features
- 4 Sender Unit Layout
- 5 Sender Unit Descriptions
- 6 Receiver Unit Layout
- 7 Receiver Unit Descriptions
- 8 Connecting the Extender For HDMI 3DTV
- 8 Wiring Diagram
- 9 DIP Switch Configuration
- 11 Network Cable Wiring Diagram
- 12 Wall Mounting Instructions
- 13 Specifications
- 14 Warranty

INTRODUCTION

Congratulations on your purchase of the Extender for HDMI 3DTV. Your complete satisfaction is very important to us.

GefenToolbox

GefenToolbox is a unique product line catering to the growing needs for innovative home theater solutions. We specialize in total integration for your home theater, while also focusing on going above and beyond customer expectations to ensure you get the most from your hardware. We invite you to explore our distinct product line and hope you find your solutions. Don't see what you are looking for here? Please call us so we can better assist you with your particular needs.

The GefenToolbox Extender for HDMI 3DTV

The GefenToolBox Extender for HDMI 3DTV extends HDMI including multi-channel digital audio at resolutions of up to 1080 Full HD and 4K (4096 x 2160 @ 24Hz) up to 330 feet (100 meters) using one CAT-5e cable for the extension. This product also provides an IR back channel to control AV sources using the same CAT-5 cable extension. Using this channel with the built-in IR "eye" on the receiver, or an optional RMT IR Extender, simply point IR remote(s) of the A/V device towards the display to control Hi-Def sources as if they were located in the same room or proximity to the display.

How It Works

Locate the GefenToolBox Extender for HDMI 3DTV Sender unit next to the video source equipment. Use the supplied HDMI cable to connect the source to the Sender unit. The Receiver unit is located close to the display which can be up to 330 feet (100 meters) away from the Sender unit. The display plugs into the back of the Receiver unit. For IR extension, either the Receiver should be located so the internal IR "eye" can see the IR signals at the display location, or an external Gefen EXT-RMT-EXTIR IR Extender may be plugged into the Receiver and located near the display. Connect a Gefen EXT-2IREMIT IR Blaster to the Sender and locate the blasters near the source equipment. Only one CAT-5e cable connects the Sender and the Receiver units to each other. Multi-channel digital audio is embedded into the HDMI signal.

OPERATION NOTES

READ THESE NOTES BEFORE INSTALLING OR OPERATING THE EXTENDER FOR HDMI 3DTV

- CAT-5 or CAT-6 cables should not exceed 330 feet (100 meters).
- Shielded (STP) CAT-5 or CAT-6 is recommended. However, unshielded (UTP) CAT-5 or CAT-6 is acceptable.



NOTE: Shielded cable has an advantage by providing immunity to Electromagnetic Interference (EMI) from cell phones and A/C motors.

- The Extender for HDMI 3DTV features the ability to generate compatible EDID and Hot Plug signals for troubleshooting purposes when dealing with difficult interfacing issues between Source devices and Displays. See pages 9 - 10 for details.
- HDCP content is not supported when the unit is in DVI mode. See page 10 for details.

FEATURES

HDMI Features

- 225 MHz (up to 12-bit YUV 4:4:4 @ 1080p60)
- Deep Color
- Dolby® TrueHD and DTS-HD® Master Audio™
- Lip-Sync
- CEC Pass-Through

Features

- Extends resolutions up to 1080 Full HD and 4K (4096 x 2160 @ 24 Hz) up to 330 feet (100 meters) using one CAT-5e (or better) cable
- 3DTV Pass-Through
- Supports high bit-rate multi-channel audio formats (Dolby® TrueHD and DTS-HD® Master Audio™) embedded in the HDMI signal
- Internal / External EDID Management
- Locking power connectors
- Built-in IR backchannel allows IR remote control of Source devices
- Metal enclosure improves RF-shielding
- All-digital signal transmission for zero signal loss
- Optional IR Blaster allowing IR remote control of Hi-Def source devices from the remote viewing location
- HDCP-compliant

Package Includes

- (1) Extender for HDMI 3DTV Sender Unit
- (1) Extender for HDMI 3DTV Receiver Unit
- (1) 6 ft. HDMI cable (M-M)
- (2) 5V DC Locking Power Supplies
- (1) Quick Start Guide

SENDER UNIT LAYOUT

Left

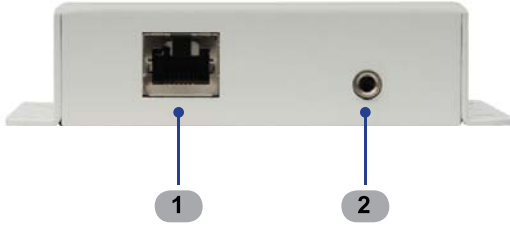

Top



Right

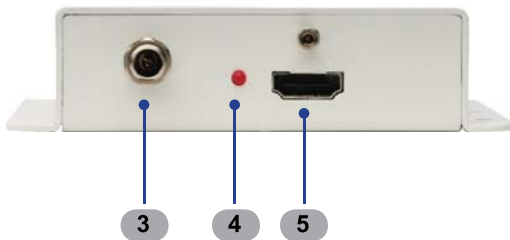

SENDER UNIT DESCRIPTIONS

1 Link

Connects the Sender to the Receiver unit using CAT-5 cabling.

2 Ext IR

Connect an IR Blaster cable from this port to the Hi-Def source to control the source from the viewing location (IR Blaster not included).

3 5V DC

Connect the included 5V DC locking power supply to this connector. Only use the power supply shipped with this unit.

4 Power

This LED will turn bright red once the included 5V DC locking power supply has been properly connected to the unit and the locking power supply has been connected to an available wall outlet.

5 HDMI

Connect a 3D Hi-Def source device to this locking HDMI port. See the Features section on page 3 for supported HDMI features.

RECEIVER UNIT LAYOUT

Left

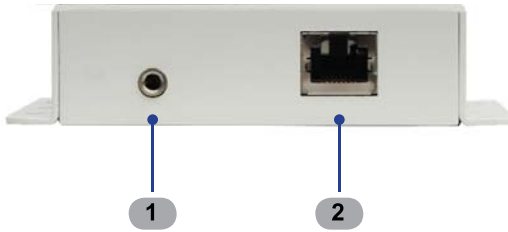

Top

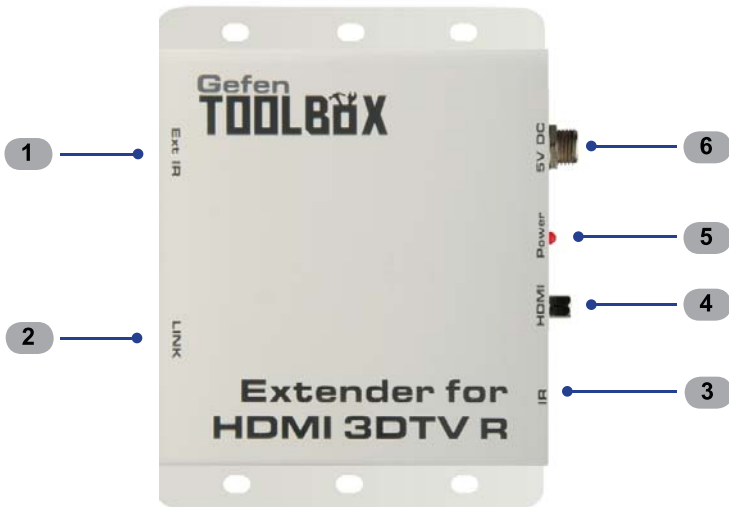

Right

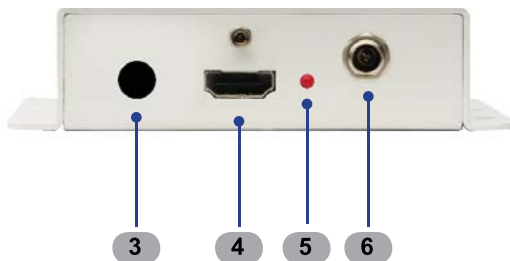

RECEIVER UNIT DESCRIPTIONS

1 Ext IR

Connect an IR extender (Gefen part no. RMT-IR-EXT) to this port.

2 Link

Connects the Receiver to the Sender unit using CAT-5e (or better) cabling.

3 IR

Receives signals from the 3D source IR remote control. The IR signals are sent back to the source device, when using an IR Blaster on the Sender.

4 HDMI

Connect a 3D display to this locking HDMI port. See the Features section on page 3 for supported HDMI features.

5 Power

This LED will turn bright red once the included 5V DC locking power supply has been properly connected to the unit and the locking power supply has been connected to an available wall outlet.

6 5V DC

Connect the included 5V DC locking power supply to this connector. Only use the power supply shipped with this unit.

CONNECTING THE EXTENDER FOR HDMI 3DTV

How to Connect the Extender for HDMI 3DTV

1. Position the Extender for HDMI 3DTV sender unit near the Hi-Def source and the receiver unit next to the display. Connect the Hi-Def source to the sender with the provided locking HDMI cable. Connect the HDTV display to the receiver unit with an HDMI cable.
2. Connect the sender and receiver units together using a single user-supplied CAT-5e or CAT-6 cables.



NOTE: If terminating network cables in the field, please adhere to the TIA/EIA568B specification (see page 11).

3. Connect a 5V DC locking power supplies to the sender unit. Connect a 5V DC locking power supply to the receiver unit. Do not overtighten the locking connectors. Plug the two power supplies to an available wall outlet. The LED on both the Sender and Receiver will turn bright red, indicating that both units are powered.
4. Power on the HDTV display and the Hi-Def source. A vibrant HDTV HD picture will be seen, along with multichannel digital audio (if the display supports audio).



NOTE: If the source and display support 3D then the Extender for HDMI 3DTV will pass through the 3D signal.

Wiring Diagram for the Extender for HDMI 3DTV

**Gefen
TOOLBOX**

CAT5 LINK CABLE (Up to 330 ft)
HDMI CABLE

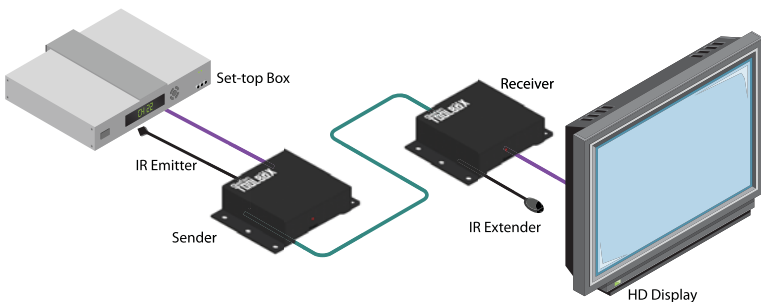

GTB-HDMI-3DTV

DIP SWITCH CONFIGURATION

DIP Switch Location

On the bottom of the Extender for HDMI 3DTV Receiver unit there are four (4) DIP switches.

The DIP switches allow advanced EDID management of the Extender for HDMI 3DTV which may be necessary when troubleshooting or using different brands of hardware. The DIP switches allow control over the EDID and the HPD (Hot Plug Detect) status.

Receiver Unit DIP Switches

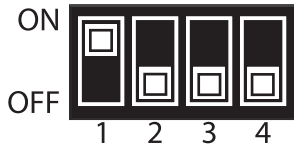

NOTE: DIP switch 4 is not used.

Default settings for DIP switches

DIP Switch	Position
1	ON
2	OFF
3	OFF
4	NOT USED

DIP SWITCH CONFIGURATION

DIP 1 - EDID Mode

ON (default) - External EDID Mode

- DDC and HPD are passed through. Both the connection status and the full A/V capabilities of the display. The HPD status will also be detected by the source device.

OFF - Internal EDID Mode

- Local EDID is used instead of the EDID from the display device. EDID features newer than HDMI 1.3 are removed when the display is read. This provides a general EDID which is compatible with more displays.

DIP 2 - Hot-Plug Detect

DIP switch 2 only works when DIP switch 1 is set to the OFF position.

ON - HPD Pass-Through

- HPD follows upstream HPD towards the source. The HPD signal will reflect the connection status between the display device and the source device. If the source or display is temporarily disconnected then reconnected, there will be a delay of 20 - 30 seconds before the A/V content is restored to the display.

OFF (default) - HPD Always High

- The HPD signal remains high regardless of the downstream HPD state. If the source or display device does not properly handle HPD (no picture after connecting / reconnecting source or display), set this DIP switch to the OFF position.

DIP 3 - Supports DVI Connections

ON

- Set DIP switch 3 to the ON position when using a DVI source or display. HDCP content is *not* supported in this mode.

OFF (default)

- If HDMI is connected, set DIP 3 in the OFF position.

NETWORK CABLE WIRING DIAGRAM

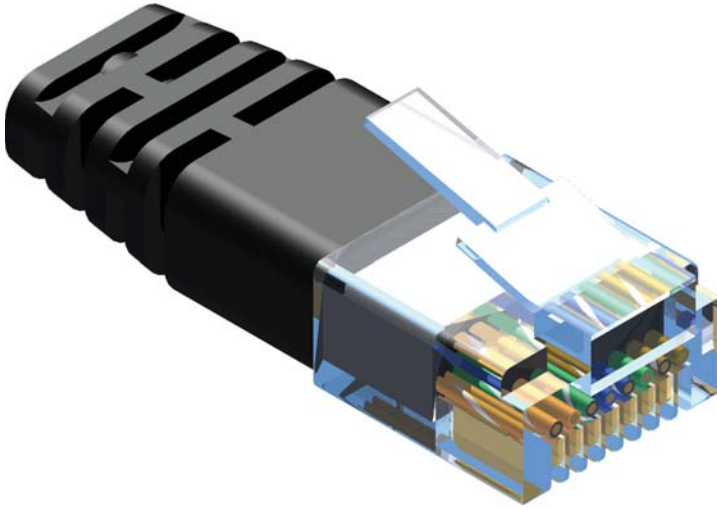

Gefen recommends the TIA/EIA-568-B wiring option. Please adhere to the table below when field terminating cable for use with Gefen products.

Pin	Color
1	Orange / White
2	Orange
3	Green / White
4	Blue
5	Blue / White
6	Green
7	Brown / White
8	Brown

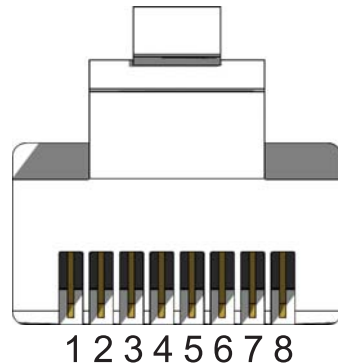

CAT-5, CAT-5e, and CAT-6 cabling comes in stranded and solid core types. Gefen recommends using solid core cabling. CAT-6 cable is also recommended.

It is recommended to use one continuous run from one end to the other. In some cases, connecting through a patch might not work.

WALL MOUNTING INSTRUCTIONS

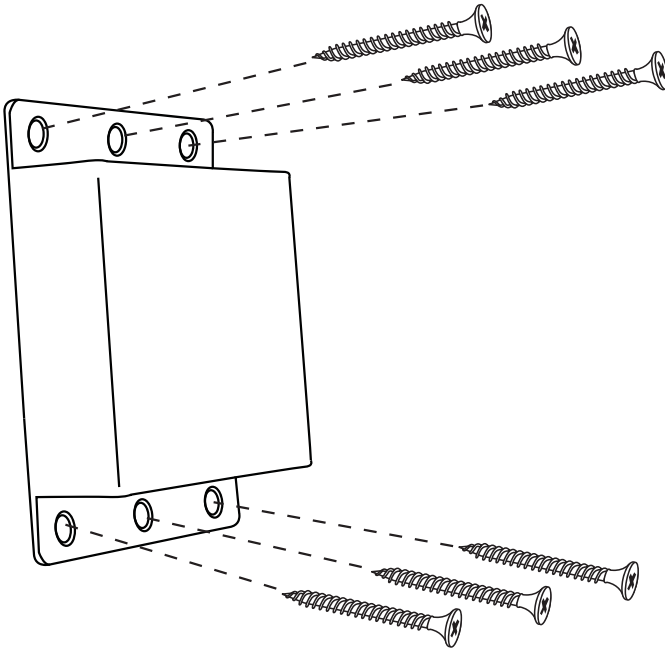

The GefenToolbox Extender for HDMI 3DTV should be mounted vertically on a wall or inside / outside a cabinet with wood / drywall screws as shown in the diagram above. There should be an inch or two of clearance between the edges of the unit and any walls or vertical surfaces to allow for enough clearance for connection and disconnection of the HDMI cable.

For installation on a drywall surface, use a #6 drywall screw. When installing, it is recommended to use the center hole on a stud.

SPECIFICATIONS

Maximum Pixel Clock.....	225 MHz
Video Input Connector (Sender).....	(1) HDMI Type-A , 19-pin, female
Video Output Connector (Receiver).....	(1) HDMI Type-A , 19-pin, female
Link Connectors (Sender / Receiver).....	(1) RJ-45, shielded
IR Blaster Port (Sender).....	(1) 3.5mm mini-mono jack
IR Extender Port (Receiver).....	(1) 3.5mm mini-stereo jack
Power Indicators (Sender / Receiver).....	(1) LED, red
Power Supply Connectors (Sender / Receiver).....	(1) 5V DC, locking
Power Consumption.....	10W per unit (max.)
Operating Temperature	0 - 40 °C
Dimensions (W x H x D) (Sender / Receiver).....	4.5" x 3.25" x 1.0" (107mm x 82mm x 25mm)
Shipping Weight.....	2 lbs. (0.9 kg)

WARRANTY

Gefen warrants the equipment it manufactures to be free from defects in material and workmanship.

If equipment fails because of such defects and Gefen is notified within two (2) years from the date of shipment, Gefen will, at its option, repair or replace the equipment, provided that the equipment has not been subjected to mechanical, electrical, or other abuse or modifications. Equipment that fails under conditions other than those covered will be repaired at the current price of parts and labor in effect at the time of repair. Such repairs are warranted for ninety (90) days from the day of reshipment to the Buyer.

This warranty is in lieu of all other warranties expressed or implied, including without limitation, any implied warranty or merchantability or fitness for any particular purpose, all of which are expressly disclaimed.

1. Proof of sale may be required in order to claim warranty.
2. Customers outside the US are responsible for shipping charges to and from Gefen.
3. Copper cables are limited to a 30 day warranty and cables must be in their original condition.

The information in this manual has been carefully checked and is believed to be accurate. However, Gefen assumes no responsibility for any inaccuracies that may be contained in this manual. In no event will Gefen be liable for direct, indirect, special, incidental, or consequential damages resulting from any defect or omission in this manual, even if advised of the possibility of such damages. The technical information contained herein regarding the features and specifications is subject to change without notice.

For the latest warranty coverage information, please visit Gefen's Warranty web page at <http://www.gefen.com/kvm/aboutus/warranty.jsp>

PRODUCT REGISTRATION

Please register your product online by visiting Gefen's web site at <http://www.gefen.com/kvm/Registry/Registration.jsp>



20600 Nordhoff St., Chatsworth CA 91311
1-800-545-6900 818-772-9100 fax: 818-772-9120
www.gefentoolbox.com support@gefentoolbox.com



This product uses UL or CE listed power supplies.